

Contents

目录

• For KUBOTA 适用久保田

P1 - P64

• For YANMAR 适用洋马

P65 - P87

• For LIEBHERR 适用利勃海尔

P88 - P90

• For MITSUBISHI 适用三菱

P91 - P98

• For ISUZU 适用五十铃

P99 - P102

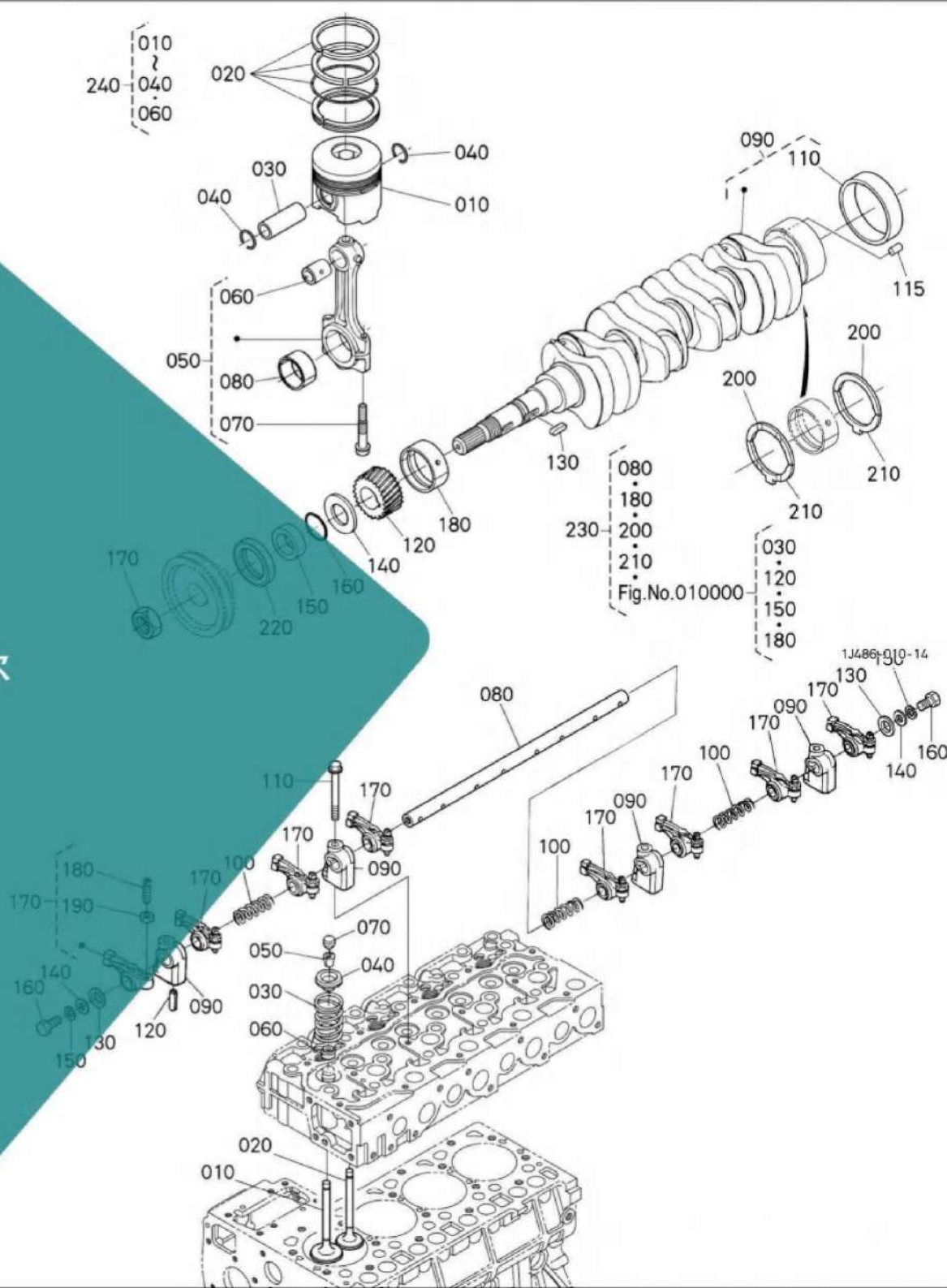



For KUBOTA



D1105



D1703



V1505



V2403-DI

All OEM part numbers and logos are to be used for identification purposes only.



V2403-IDI



V2403 For Forklift



V2607T



V3300-DI-ES02



Z482



Z602



ZB600



D722



D782



D850

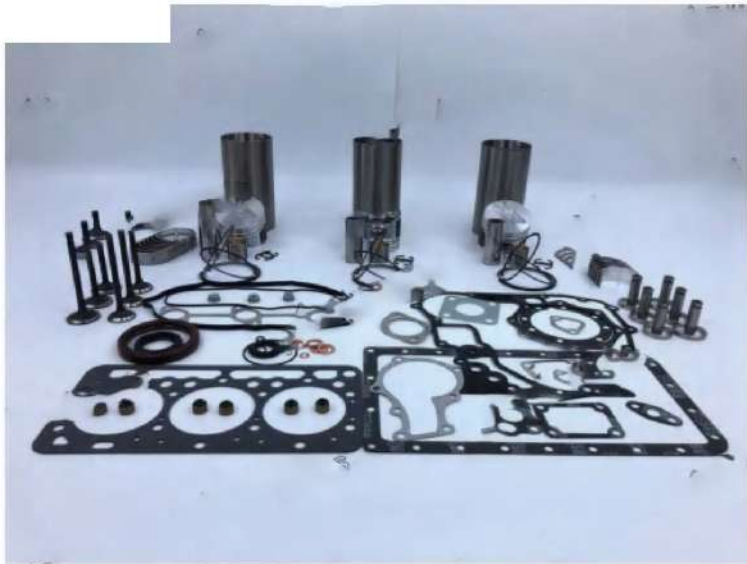

D902

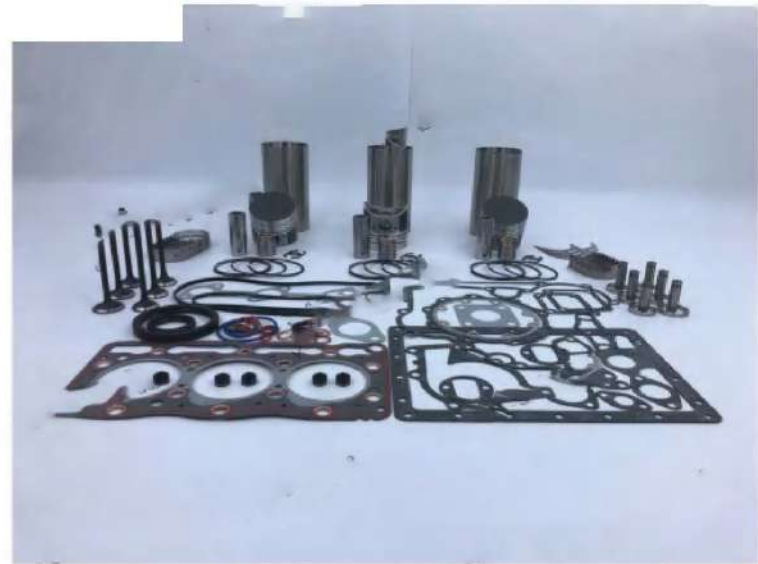

D905



D950

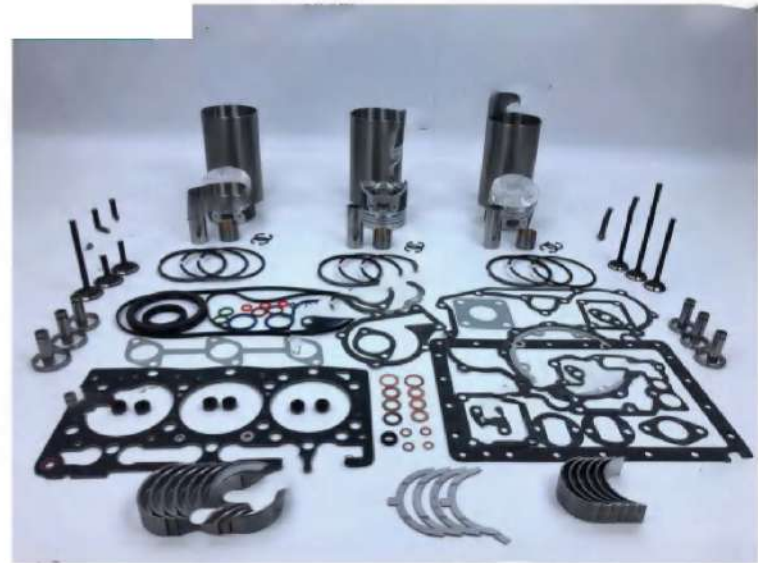

D1005

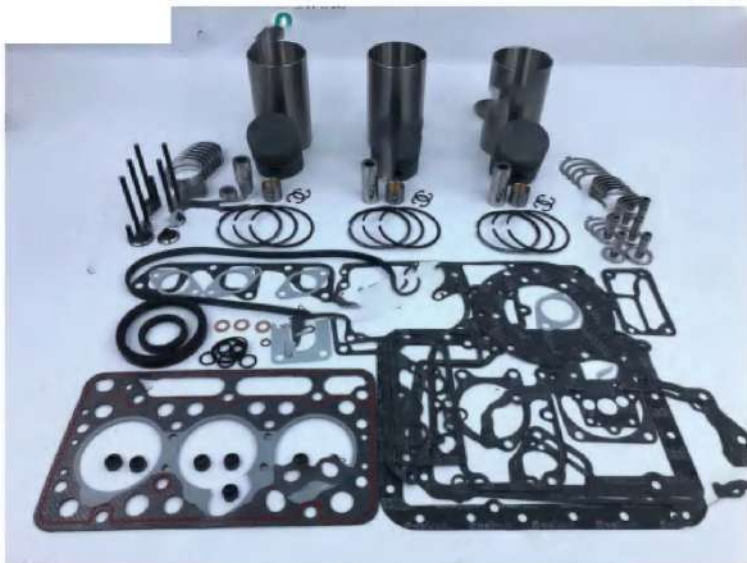

D1102

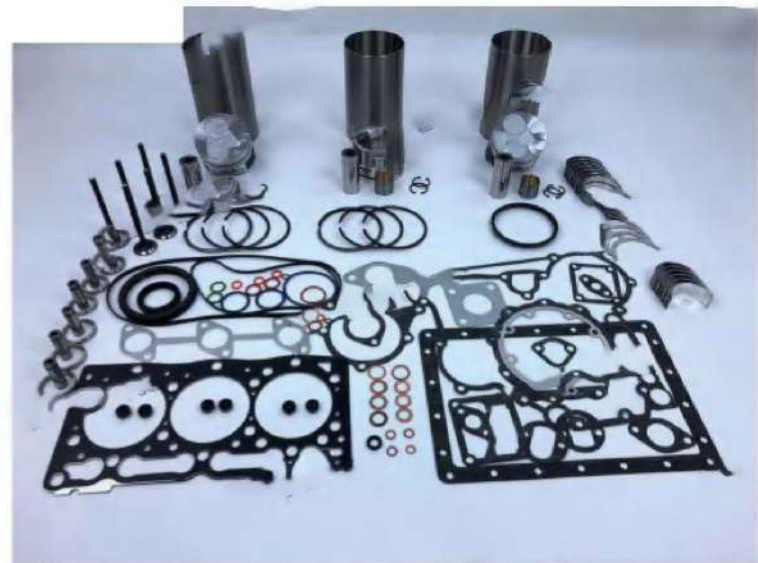

D1105

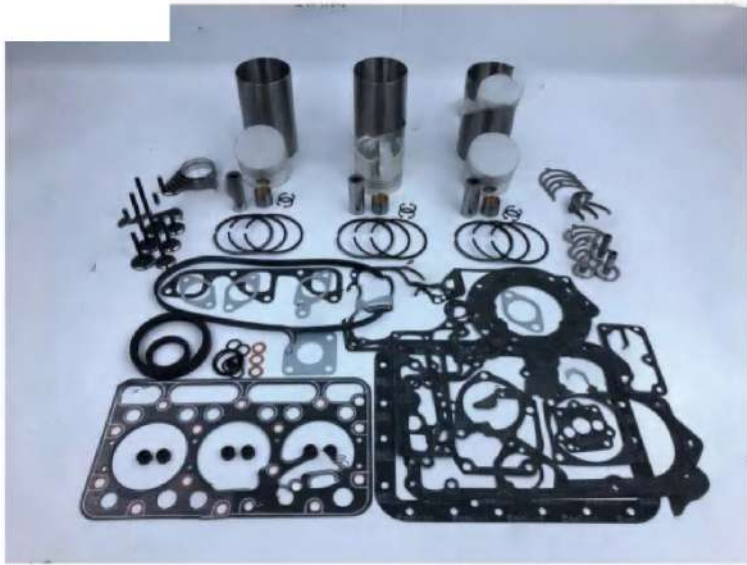

D1302



D1402



D1402



D1403



D1462



D1463



D1503



D1703



D1803



D3200



V1100



V1200

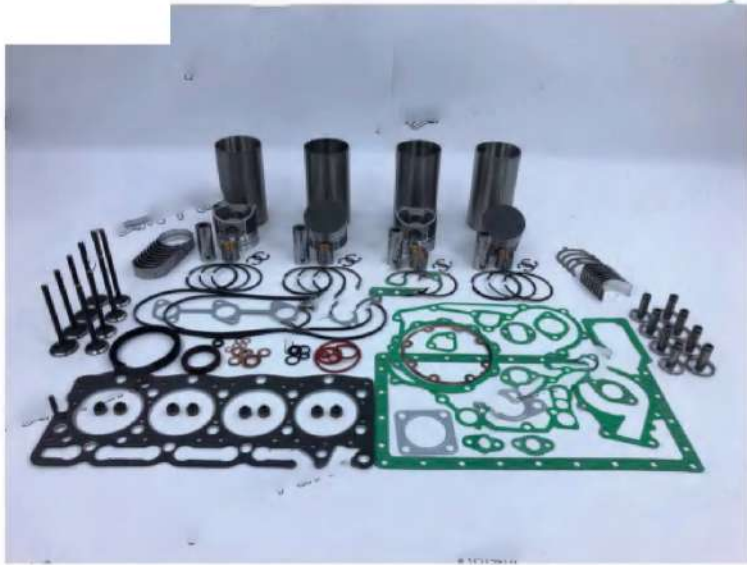

V1205

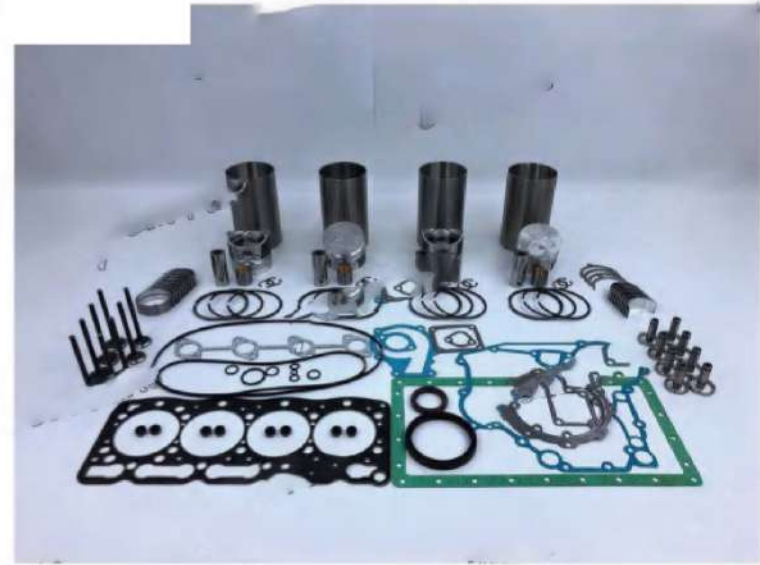

V1305



V1405

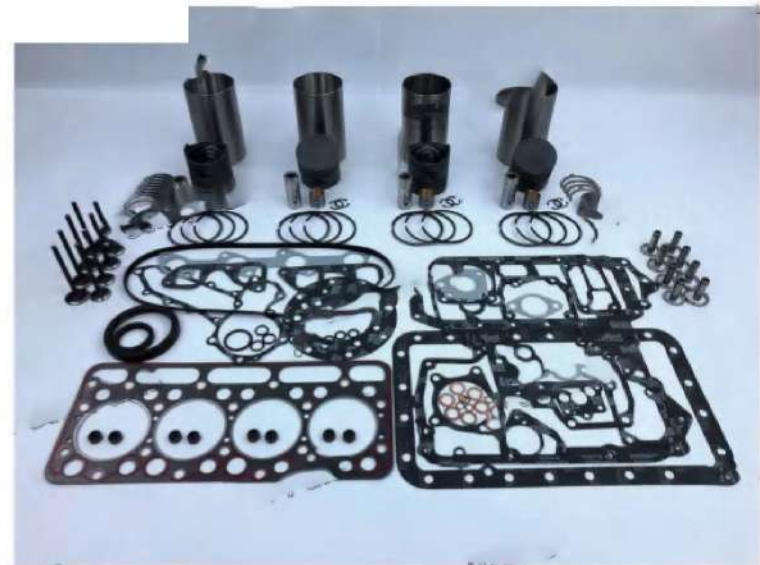

V1502

All OEM part numbers and logos are to be used for identification purposes only.



V1505

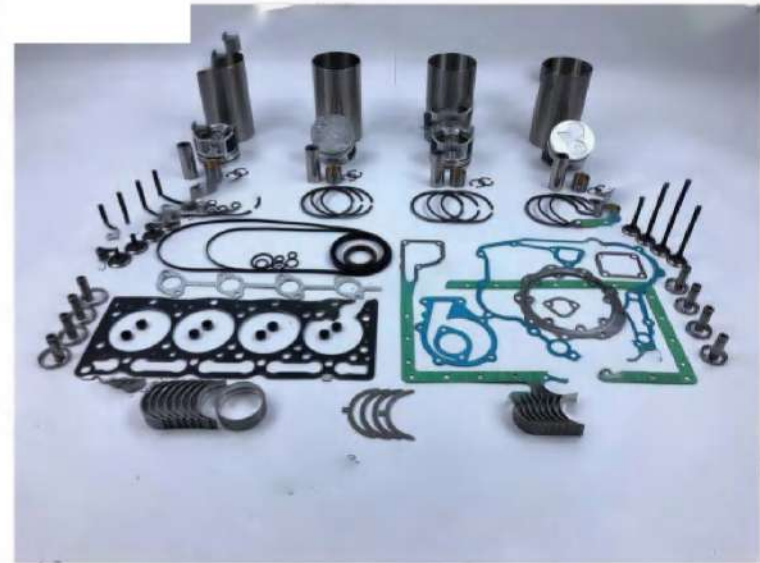

V1505



V1512



V1512

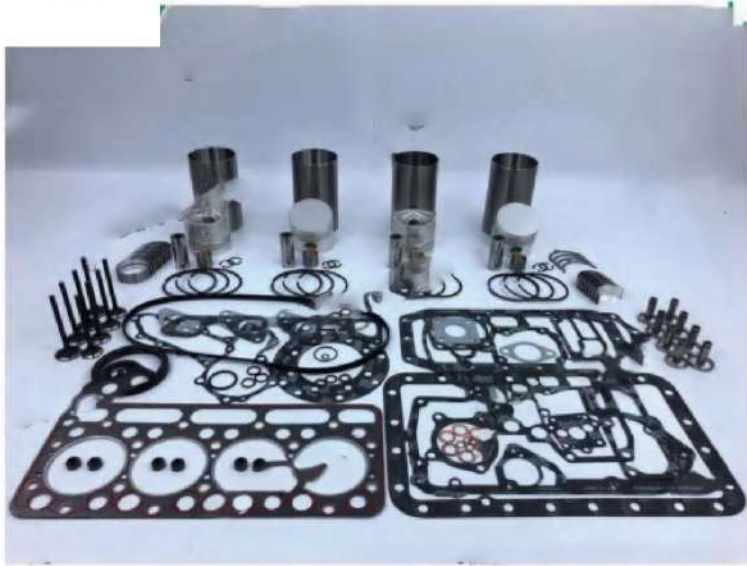

V1702

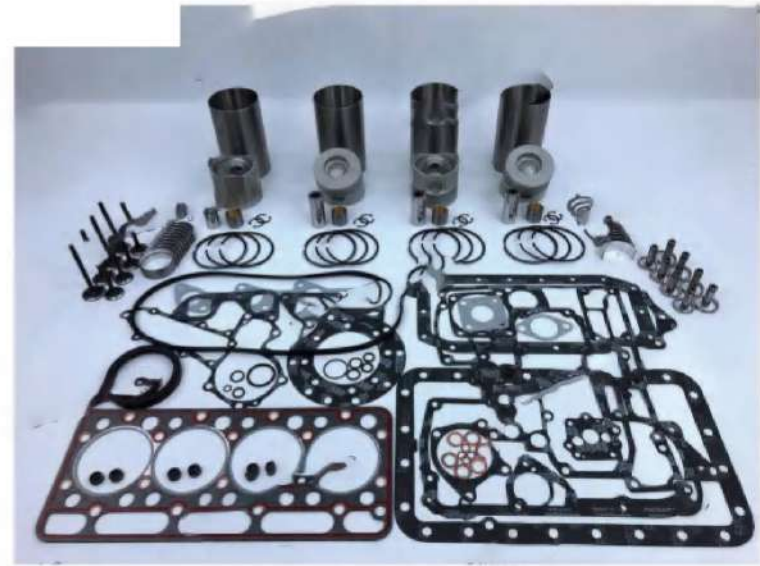

V1902

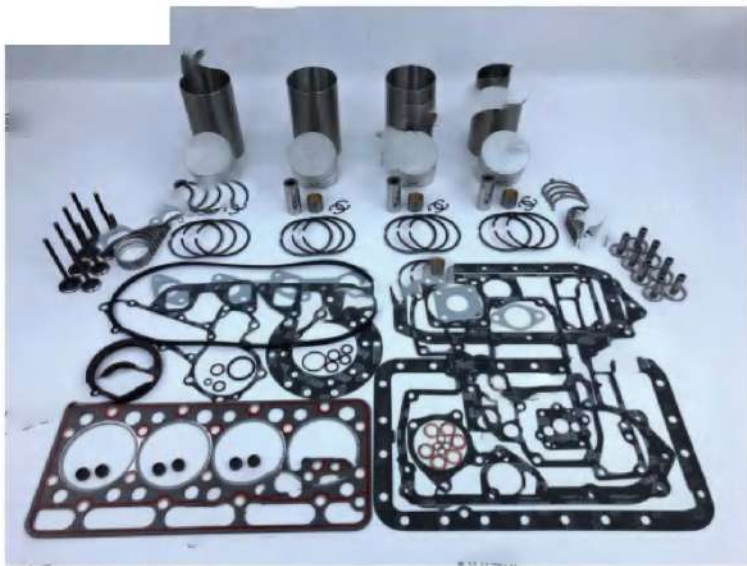

V1902

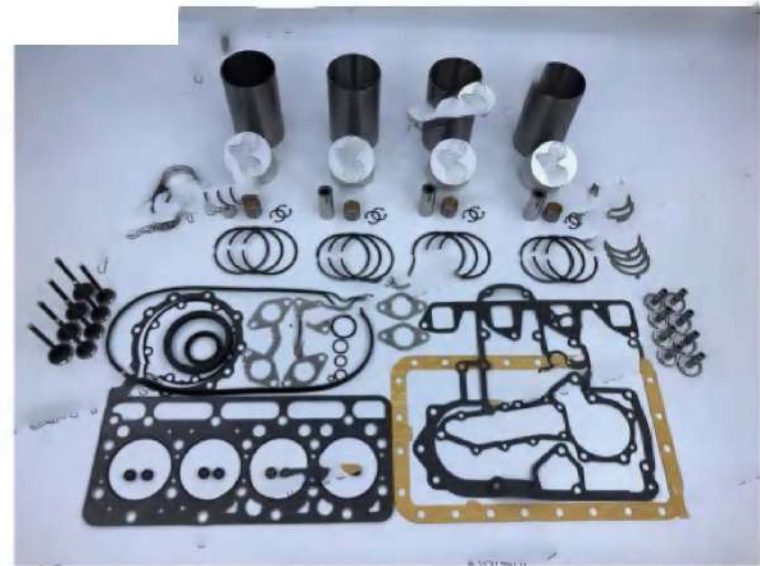

V1903

All OEM part numbers and logos are to be used for identification purposes only.



V2003



V2003

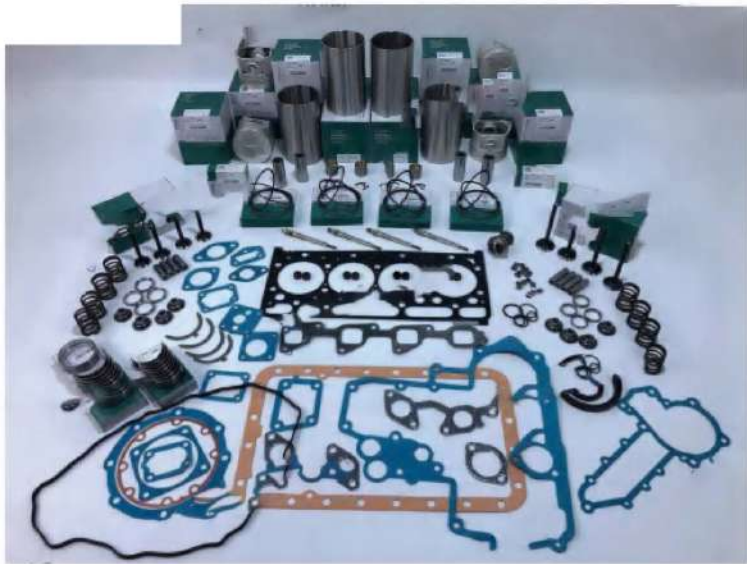

V2203

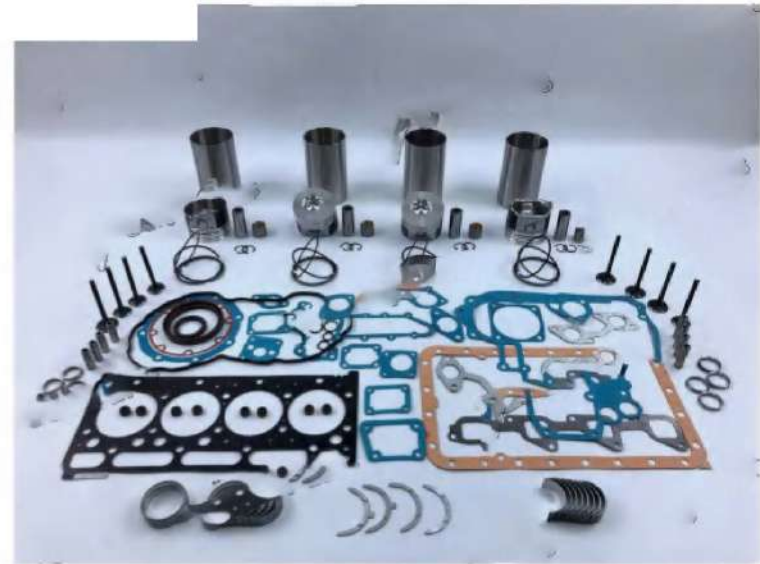

V2403



V2607



V3300

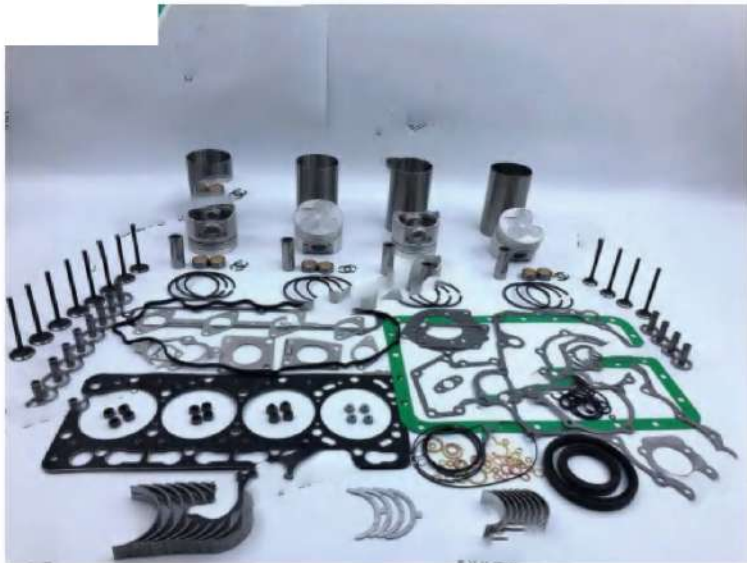

V3300



V3300

All OEM part numbers and logos are to be used for identification purposes only.



V3300

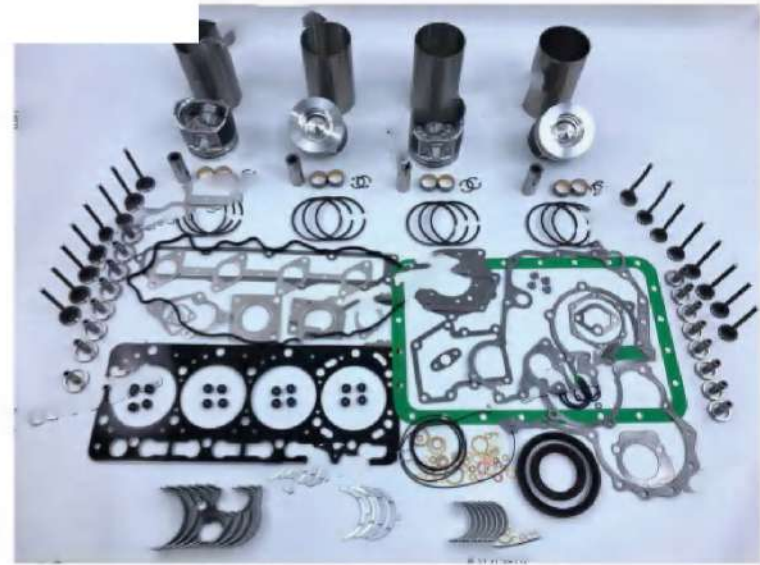

V3300



V3307

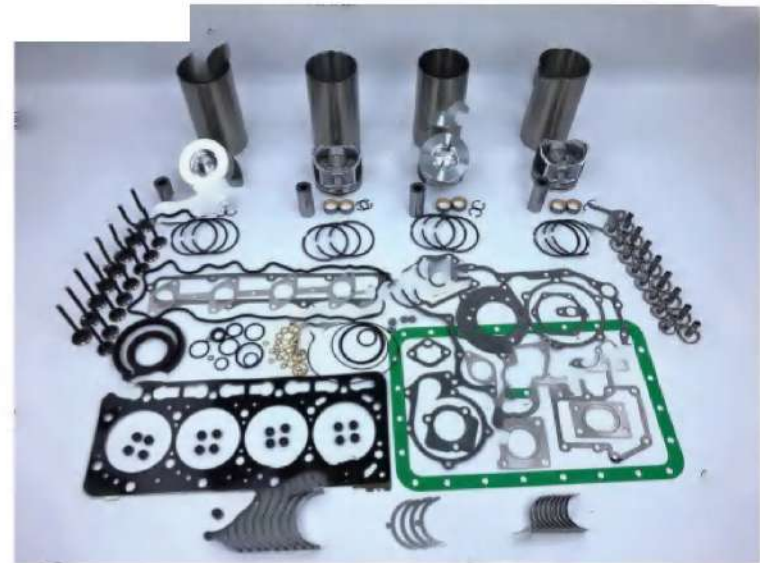

V3800



V4000



F2302



F2503



F2803

All OEM part numbers and logos are to be used for identification purposes only.

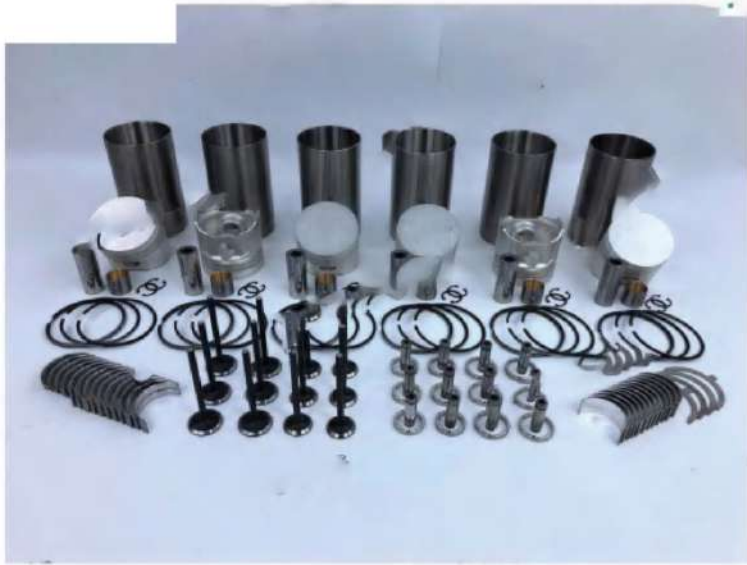

S2800

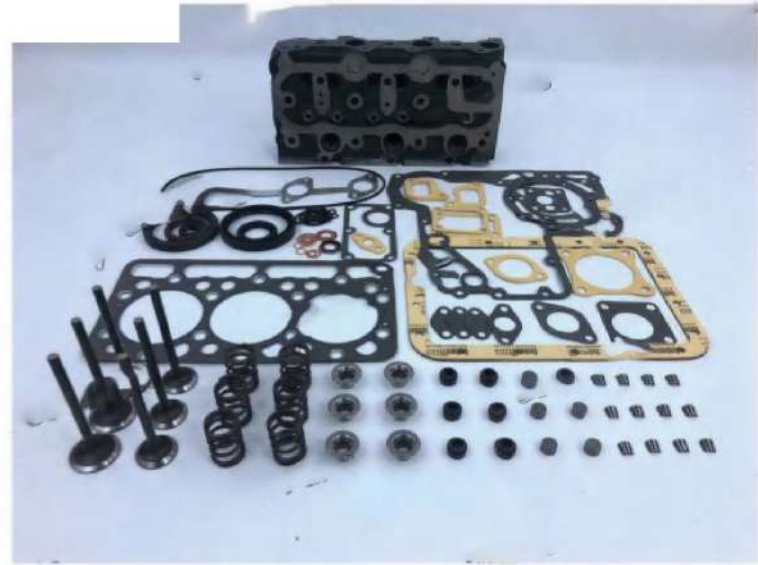

D850

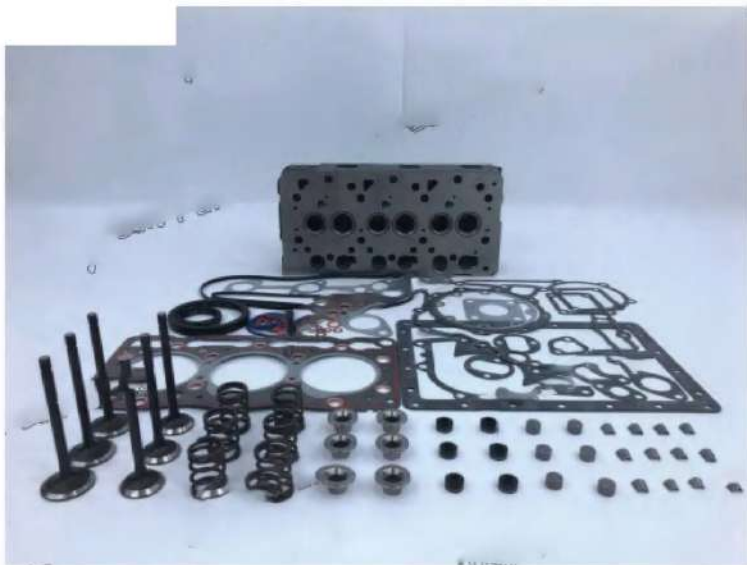

D905



D950



D1005



D1102

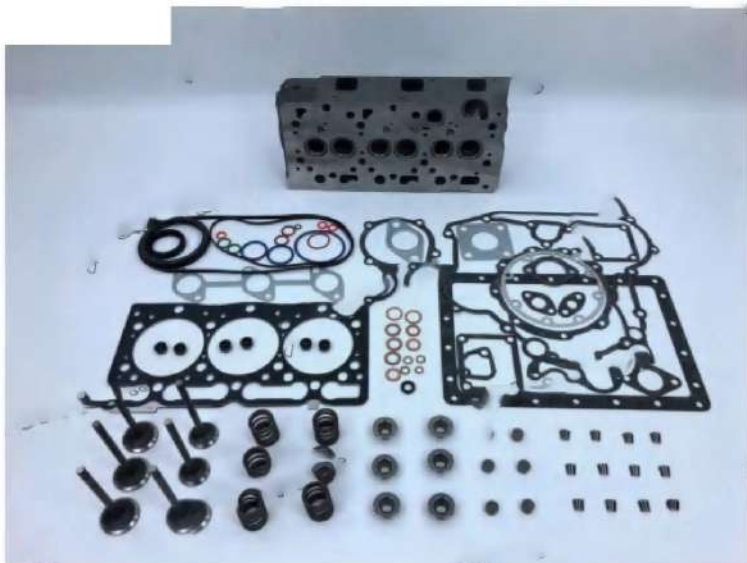

D1105



D1302



D1402



D1403

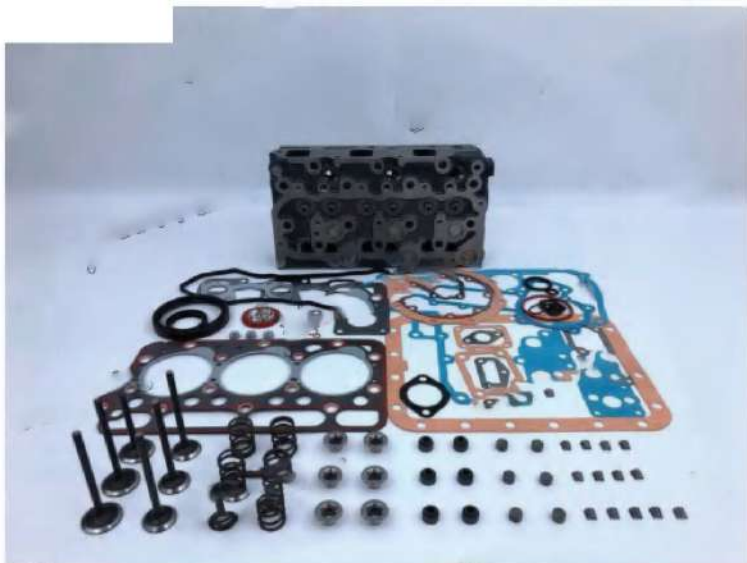

D1503

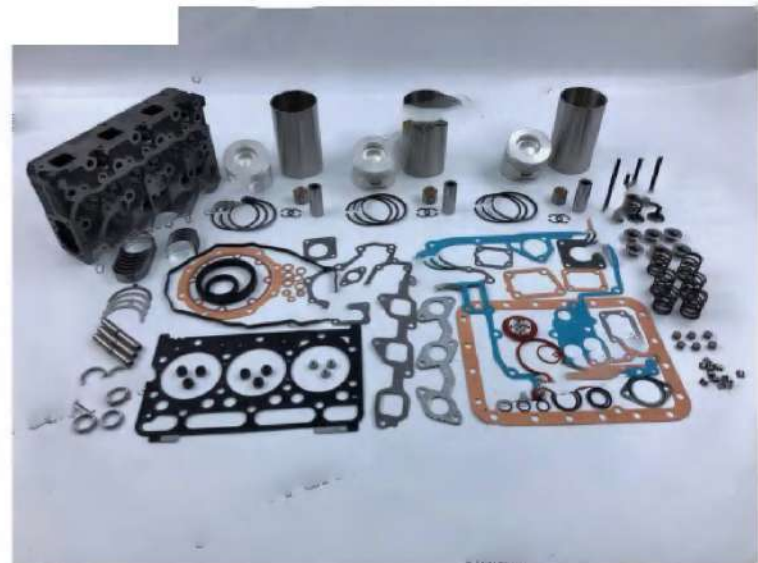

D1703

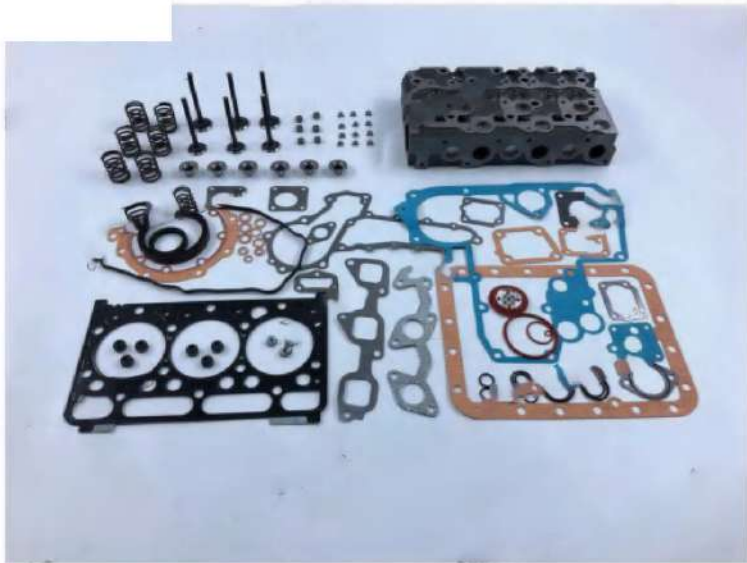

D1703

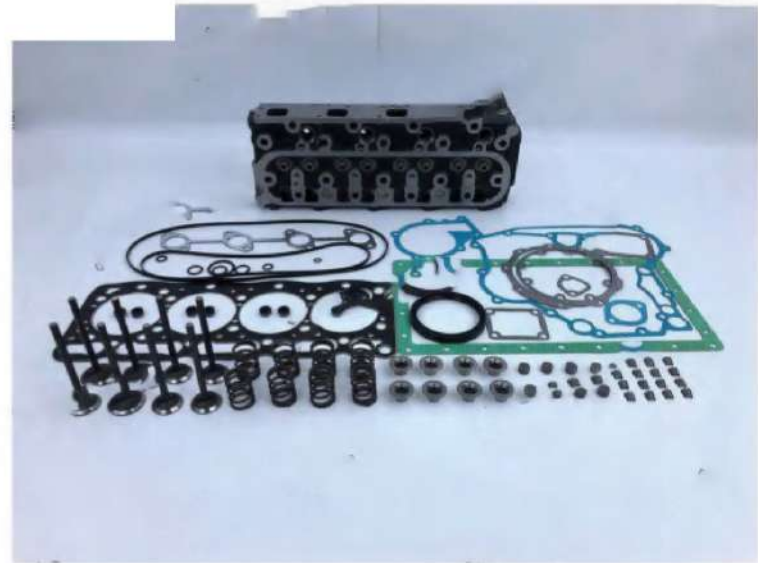

V1305



V1505



V1512



HOT SALE ENGINE MODELS FOR KUBOTA

ZB600	D950	D1503	V1505	V3300
Z602	D1102	D1703	V1512	V3307
Z482	D1005	D1803	V1702	V3600
D722	D1105	V1100	V1902	V3800
D750	D1302	V1200	V1903	V4000
D782	D1402	V1205	V2003	F2302
D850	D1403	V1305	V2203	F2503
D902	D1462	V1405	V2403	F2803
D905	D1463	V1502	V2607	S2800

All OEM part numbers and logos are to be used for identification purposes only.



Z482



D902



D722



D782



D850



D905



D950



D1005



D1105



D1402



D1403



D1462



D1503



D1703



D1803



V1200



V1205



V1502



V1505T



V1512 DI



V1512 IDI



V1702



V1902



V1903



V2203 1G796



V2203 46MM



V2203T



V2403 1G790



V2403 1G861



V2403 1G868



V2403 1J881



V2403T 1G924



V2607



V2607T



V3300 84MM



V3300 87MM



V3300 91MM



V3300 DI 52MM



V3300T 57MM



V3307 1G774



V3307 1J751



V3600



V3800T



V4000



F2503



F2803 DI



F2803



S2800



Valve & Guide & Seat



Valve Spring



Tappet & Push Rod



Valve Oil Seal



Retainer



Valve Cap



Valve Collet



Rocker ARM

Con-Rod Bearing



Main Bearing



Thrust Washer



Assy BRG. Case. Main



V2203 Bush, Crankshaft



V2203 Collar, Crankshaft



V2607 Bush, Piston Pin



V3300 Camshaft Bush



Z482



D722



D850



D905



D950



D1005



D1102



D1105



D1302



D1303



D1402

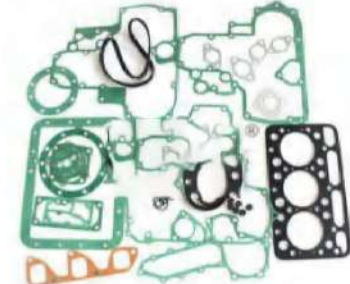

D1503



D1703



V1205

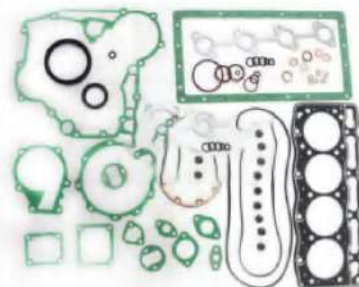

V1305

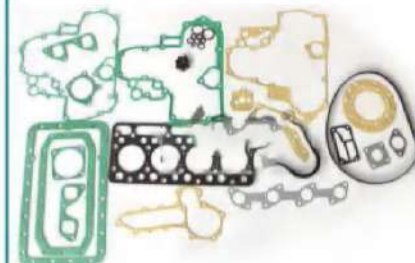

V1502



V1512

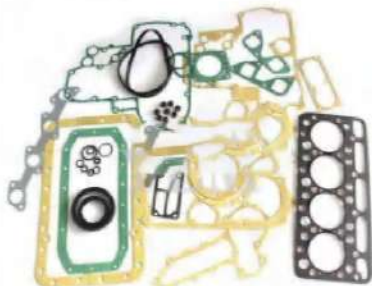

V1702



V1902



V1903



V3300 K1



V3300 K2



V3800 K1



V3800 K2

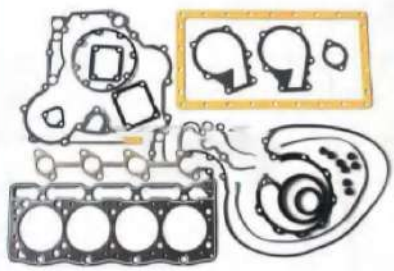

V1505

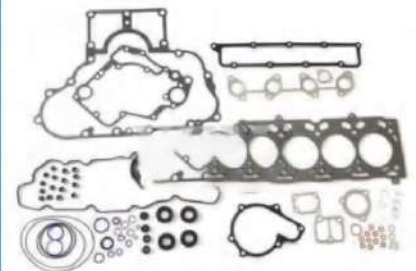

V2607



V3307



V2203 For Generator



V2203



V2203 M



V2203



V2203



V2203



V2203



V2203



V3300

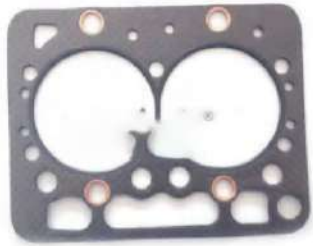

Z482



Z430



Z602



D722



D850



D902



D905



D950



D1005

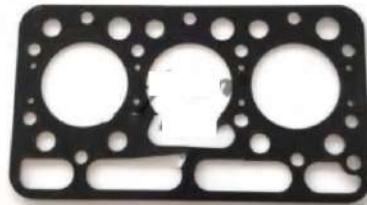

D1102



D1105



D1105 M



D1302



D1402



D1403



D1462



D1503



D1703



V1205



V1305



V1505



V1505 M



V1512



V1702

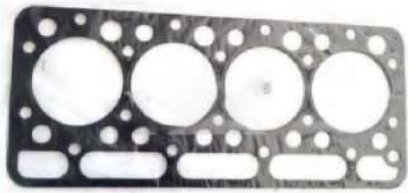

V1902



V1903



V2003



V2203 M



V2607



V3300



V3300 M



V3307

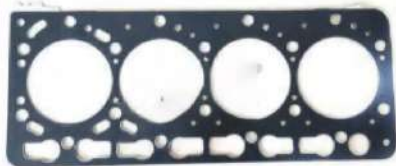

V3600



V3800



F2503



F2803



D902



D1105



V2003



V2203-01#BG1370



V2403 1G633-0101D



V2403 PC56-7 KX161



V2607



V3300-DI



V3800-DI



Z482



ZB500



ZB600

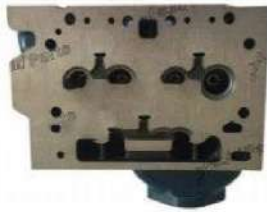

B6000



Z751



Z851



D722



D750



D782



D850



D902



D905



D950



D1005



D1102



D1105



D1302



D1305



D1402



D1403



D1462-DI



D1462-IDI



D1503



D1703



DH1100



L2000



V1305



V1502



V1505



V1512



V1702



V1902



V1903-N



V1903-0



V2003-N



V2003-0



V2203-N



V2203-O



V2403-DI



V2607



V3300-12V



V3300-16V



V3307



V3600



V3800



D722



D902



D950



D1105



D1703



V1702



V2403



V2607



V3300



V3307



V3600



V3800



Flywheel 110T



Gear For Time Cover



Bolt, Cylinder Head



YEM-286 Pin, Crankshaft



Con Rod Bolt



Gear, Crankshaft

All OEM part numbers and logos are to be used for identification purposes only.



Z482



D722



D782



D1105



D1402



D1503



V1505



V1902



V2203



V2403



V2607



V3300



V3307



V3800



V2203



V2403



V3300 76T



V3800



D782



D850



D1403



D1462



V1505



V2203-DI



V2203 O



V2203-IDI



V2607



V3300-DI



V3307



V3800T



Plunger / D.Valve / Nozzle

All OEM part numbers and logos are to be used for identification purposes only.



Z482



D662



D722



D850



D1402



D1403



D1703



V1505



V1902



V2203-IDI



V2607



V3300



V3800



D722



D1403



V1505



V2203



V2403



02 Series 15263-52030



V3800



Fuel Pump R1401-5135-2



052600-4531



1502-12C2U1B2



1502-12D6U2B2S2A 12V



1503ES-12A5UC4S



1503ES-12A5UC5S
17454-60010 SA-4569-7



1503ES-12A5UC9SCC28



1503ES-12S5SUC5S



119233-77932
1503ES-24S5SUC125



15471-60010



16271-60012



16577-60010



17208-60015



1756ES-12SULB1S5



1A021-60017



1500-3076



1C010-60017



1E152-60011



1G772-60013



1G820-60022



SA-4561-7



1503ES-12A5UC9SCC28



V3800 60018



6681513 12V



17490-60010 SA-4310-12



19434-73014



1A021-73012



1C011-73010



1E399-73010



1G772-73010



1G924-73010



D722



V2403



V3800



Oil Switch



Switch



Switch



D782



V1505



V2403



V2607



V3307



V3800



V1505



V2203



D1503



19883-73030



1E051-73030



15443-73030



1G820-73030



D850



19069-72036



16259-73010



16241-73032



1A021-73030



D1503



1K321-73030



16251-73010



1K576-73030



15424-73034



15521-73033



1A051-73032



253758110



V2403 For Forlift



V2403 V2203 KX155 PC56-7



1J700-73030



1C010-73030



1G772-73032



15321-73032



V3800



V2203



For Kubota



D722



D782



D850



D1703



V1505



V1903 19077-74110



V2203 V2403 9T8



V3300



V3300 DH70

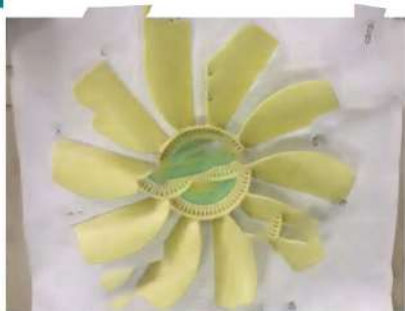

V3300 750大



V3300 V3800 4T7



V3600



V3800



D722



D600



D1005



D1503



V1100



V3800



V3800



V3800



V2403



HOT SALE ENGINE MODELS FOR KUBOTA

ZB600	D950	D1503	V1505	V3300
Z602	D1102	D1703	V1512	V3307
Z482	D1005	D1803	V1702	V3600
D722	D1105	V1100	V1902	V3800
D750	D1302	V1200	V1903	V4000
D782	D1402	V1205	V2003	F2302
D850	D1403	V1305	V2203	F2503
D902	D1462	V1405	V2403	F2803
D905	D1463	V1502	V2607	S2800



D722 12V



V1505



V1505 V1305 D1105 12A 30A



V2203



V2403



V3300



V3307 KX183 12V



V3307



Z482



D662



D722



D722



D905



D1005



D1005



D1503



D1703



V1305



V1505



V2003



V2203 V1903 12V



V2203



V2403



V2403 PC56-7 12V

All OEM part numbers and logos are to be used for identification purposes only.



KX165 KX163 V2607 12V



V3300 V3800 9T



V3307



V3800



V2003



V2403



V2607



V3300



V3307 KX185-7



V3800



D1105



V3307 S300



Z482



D850



D1402



D1803



V1902



V2203



V2403



V3300



V3800





For YANMAR



3TNE66



3TNA68



3TNE68



3TNV70

All OEM part numbers and logos are to be used for identification purposes only.



3TN72



3T72HL



3TNA72

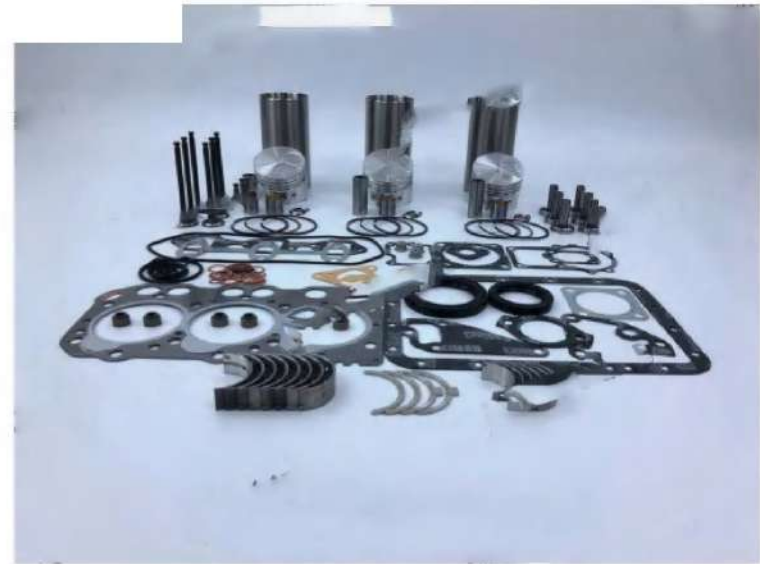

3TNE72K



3TNE74



3T75



3TNV76



3TNA78

All OEM part numbers and logos are to be used for identification purposes only.



3TNB78



3TNC78



3TNE78



3TNC80



3TN82



3TNV82



3D84-1



3D84-2

All OEM part numbers and logos are to be used for identification purposes only.



3D84-3



3TNV84



3TNE88



3TNV88

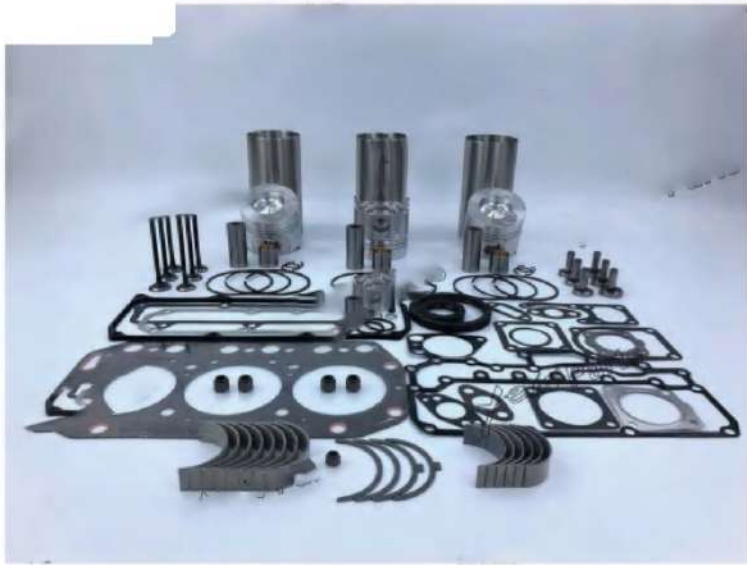

3TN100



4D84-1



4D84-2



4D84-3

All OEM part numbers and logos are to be used for identification purposes only.



4D92E



4D94E



4TNE94



4TNV94

All OEM part numbers and logos are to be used for identification purposes only.



4D98E

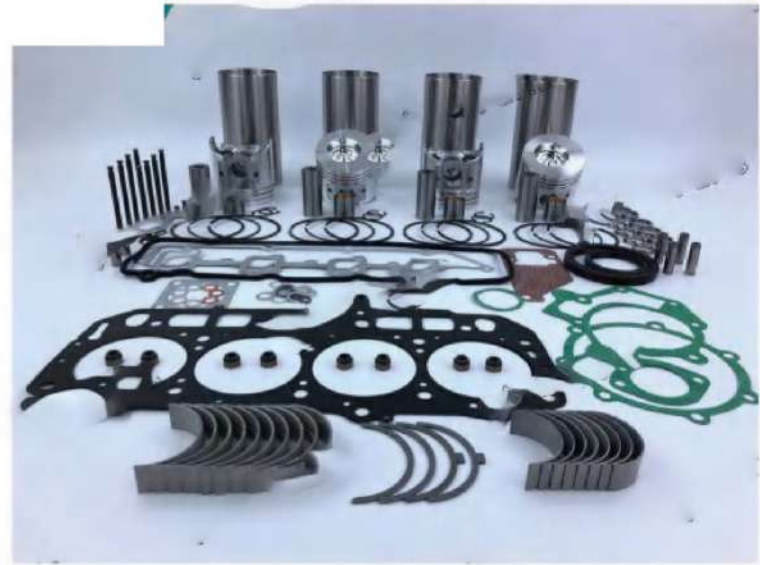

4TNE98

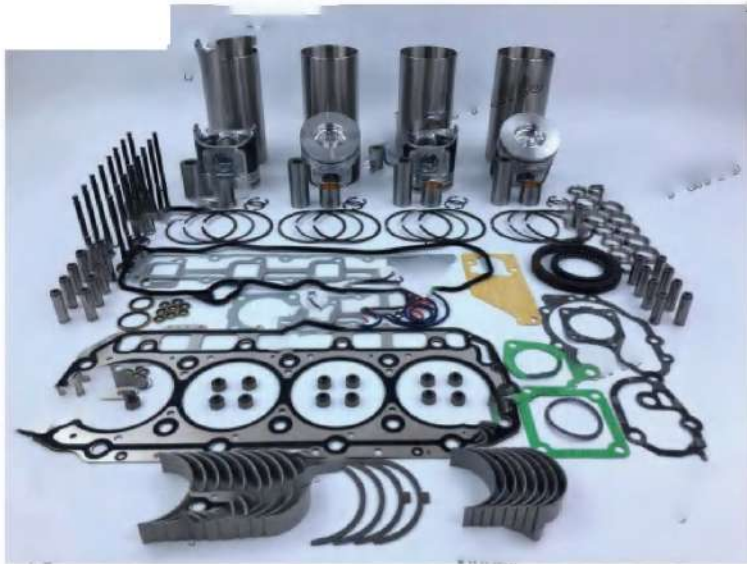

4TNV98



4TN100



4TNE106

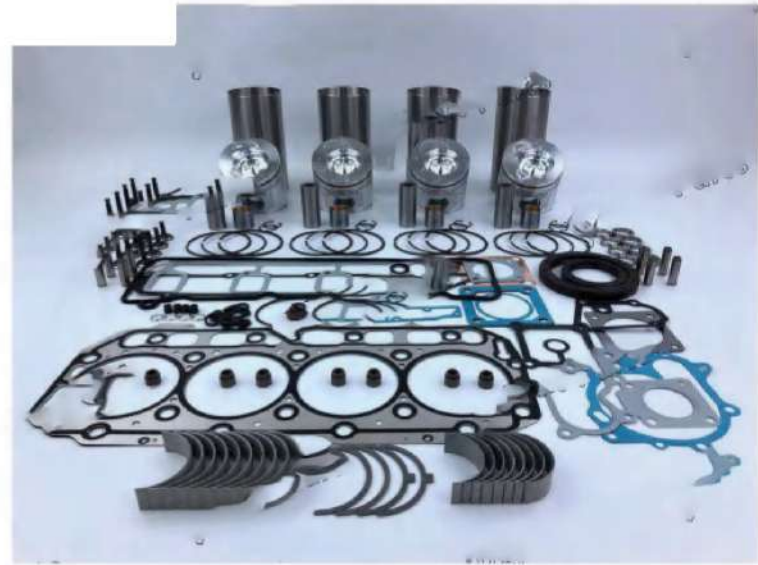

4TNE106



4TNE106



TF160



3TNA66



3TNE66



3TN66



3TNA68



3TNE68



3TNV70



3T72HL



3TNA72



3TNE72



3TNE74



3TNE74



3TN75

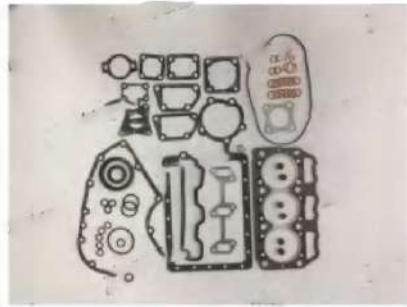

3T75HL

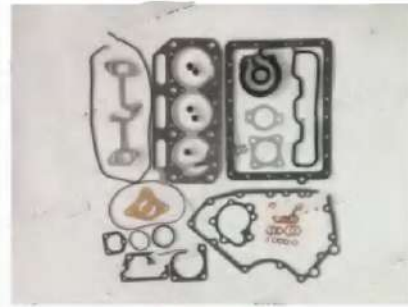

3T75HLE



3TNV76



3TNC80



3TNE78



3TNE82

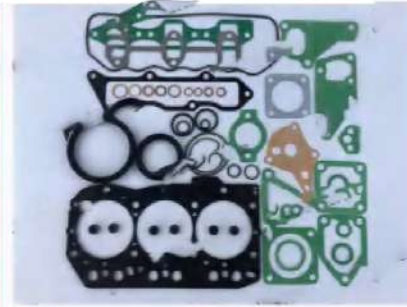

3TNV82



3D84-1

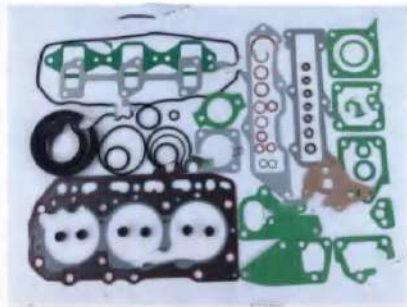

3D84-2



3D84-3



3TNE88



3TNV88

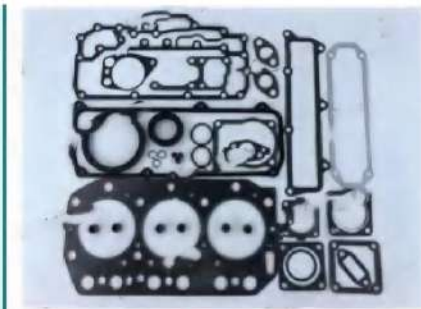

3TN100

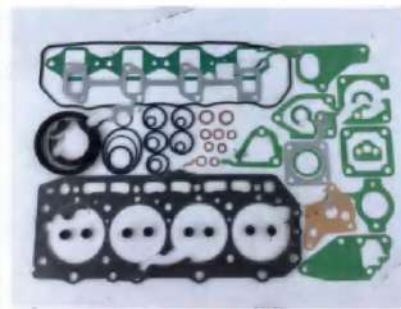

4D84-1



4D84-2

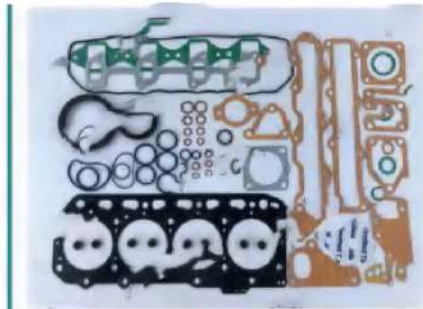

4D84-3



4TN86-N



4TNA78



4TNE82

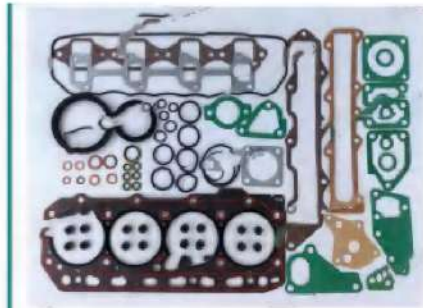

4TNV84



4TNE88

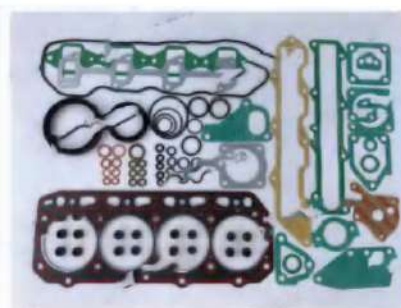

4TNV88



4TNE94



4TNV94

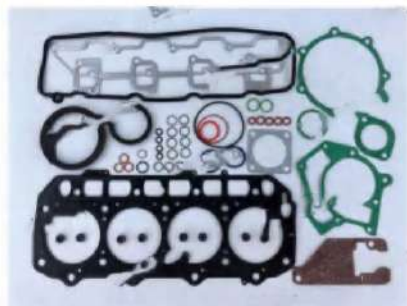

4TNE98

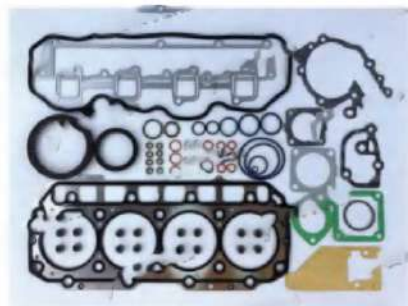

4TNV98



4TNE106

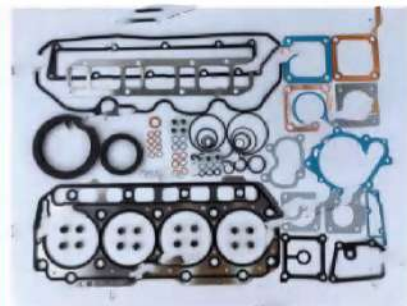

4TNV106

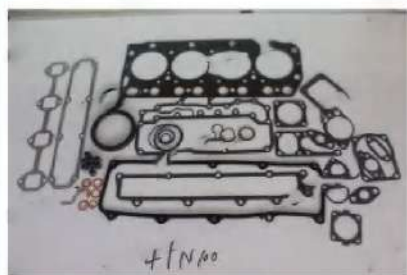

4TN100 719141-92625



2TNE68



3TN66



3TNA66



3TNE66



3TNE68 3TNA68

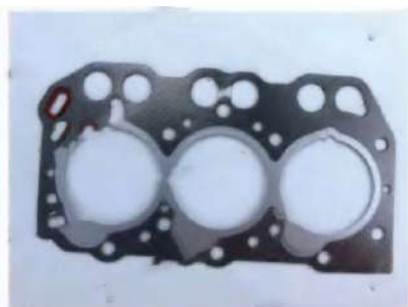

3TNA68



3TNE68



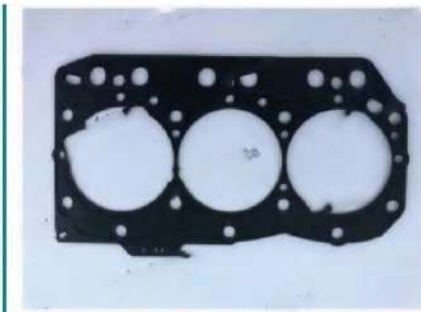

3TNE82

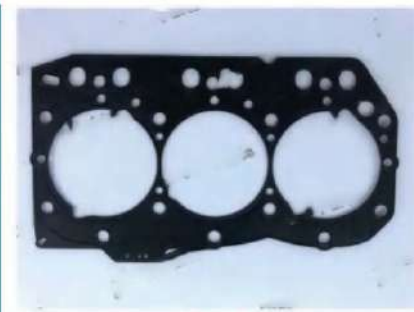

3TNV82



3D84-1



3D84-2



3D84-3A



3D84-3

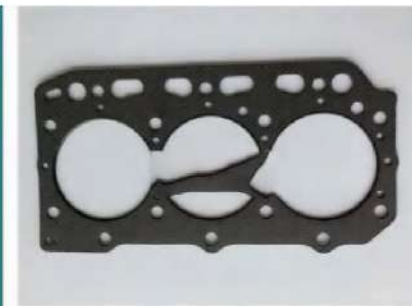

3TNV88

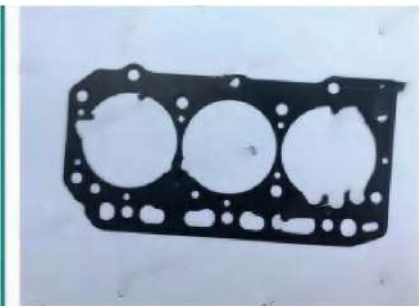

3TNE88



3TNV88



3TN100



4TNA78



4TNE82

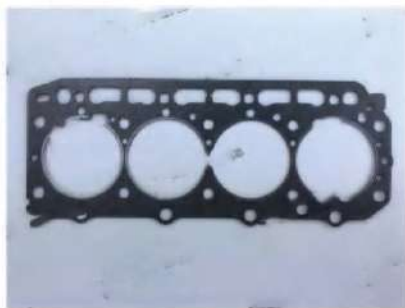

4D84-1

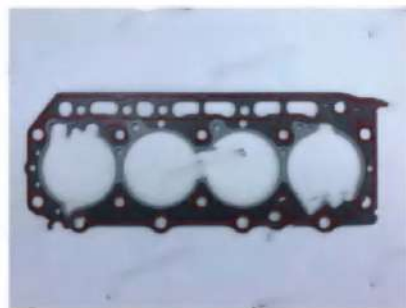

4D84-2



4D84-3



4TNV84



4TNV84



4TNE88

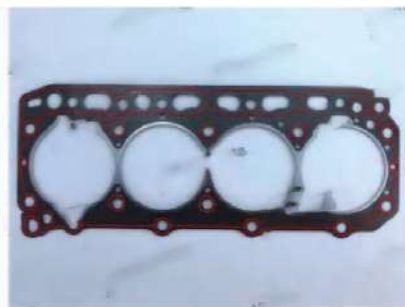

4TNE88



4TNV88



4TNV88



4NE94A



4TNE94黑铁



4TNV94



4TNV94A



4TNV94黑铁



4TNV98A



4TNV98M



4TNV98S



4NE98A

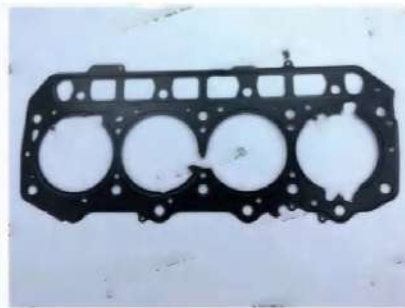

4TNE98M



4TNE98S



4TN100



4D106



TF140



TF160



3TNE68



3TNE68



3TNA72



3TNE74



3TNV76



3TNC78



3TNE78



3D82



3D84-2



3T84HL



3TNA86



4TNE82



4TNE88



4TNE88 729428-42007



4TNV88



4TNE92



4D94E



4D94LE



4TNV94



4D89-2



4TNE98



4TNE100



4D106



4TNV106



3T84HL



4D84



4TNE86



4TNV98



电子油泵 12V 黑插



电子油泵 12V



电子油泵 24V 黑插



电子油泵 24V



电子油泵 长



电子油泵带调节器 12V



感应塞



油水分离器



For LIEBHERR

All OEM part numbers and logos are to be used for identification purposes only.



R914 / R924 / R934 / R944



Cylinder Head



Water Pump



Con Rod Bolt



Oil Nozzle



Turbocharger



Connecting Rod



Fuel Pump



Oil Cooler Core



Starting Motor



Tensioner



Fan Blande



For MITSUBISHI



K3B



K3B

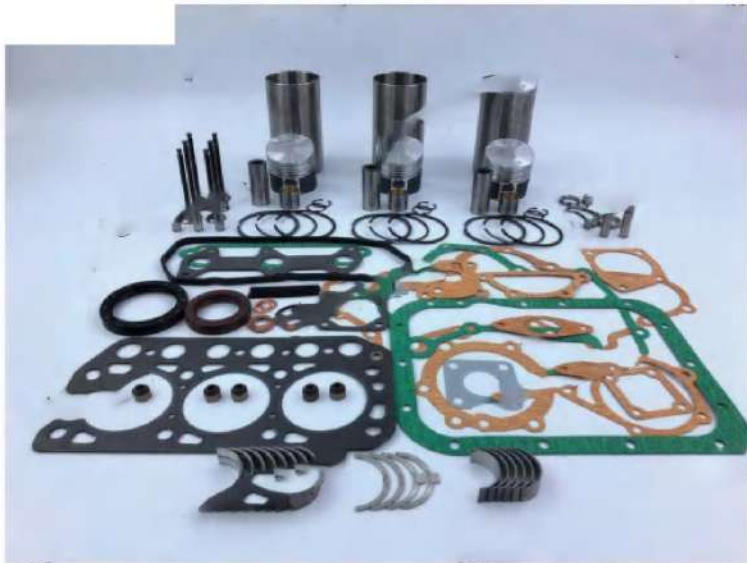

K3D

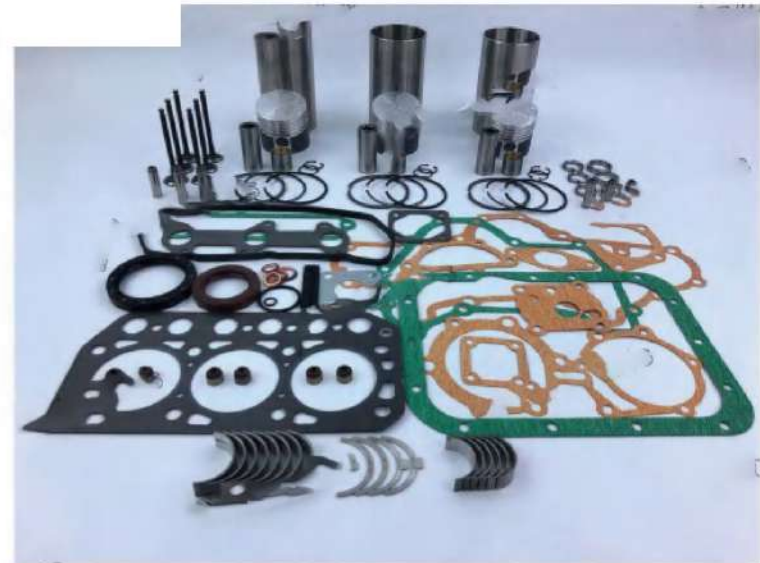

K3D



K3F



K3H



K3M



K4D



K4D



K4E



K4E



K4F

All OEM part numbers and logos are to be used for identification purposes only.



K4M

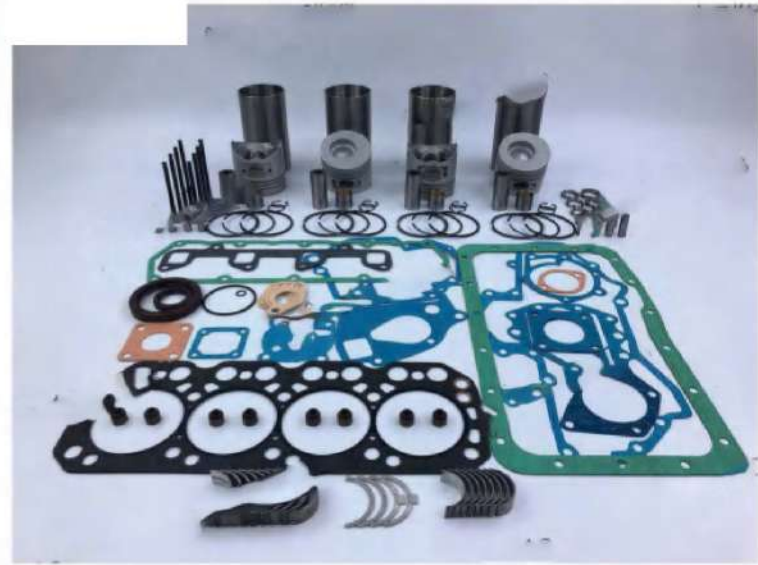

K4N



K4N



S3E-750

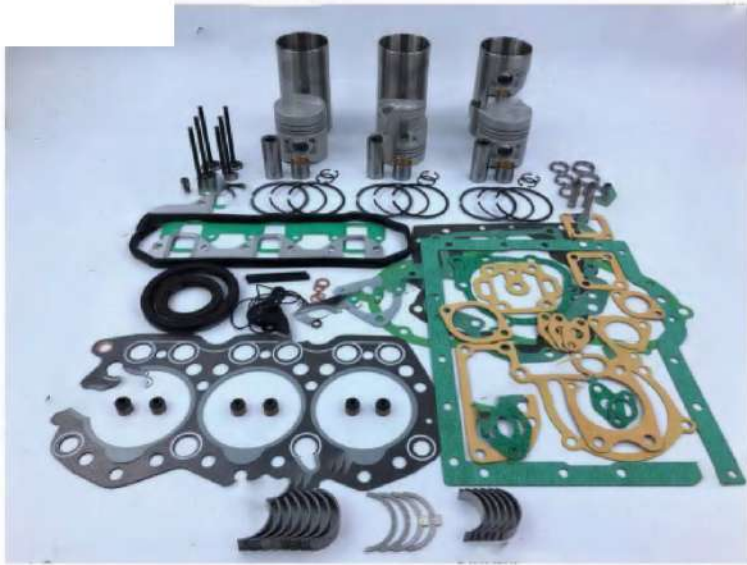

S3E



S3L



S3Q2



S4E2

All OEM part numbers and logos are to be used for identification purposes only.



S4E6



S4E



S4L



S4Q2



S4S



S4S

Hot Sale Engine Model For Mitsubishi

- 4D30
- 4D31
- 4D32
- 4D33
- 4D34
- 4D35
- 4D56
- 4DQ5
- 4M40

- 4M50
- 6D14
- 6D15
- 6D16
- 6D17
- 6D20
- 6D22
- 6D24
- 6D31

- 6D34
- 6D40
- 6M60
- 8DC11
- 8DC8
- 8DC9
- K3B
- K3D
- K3E

- K3F
- K3H
- K3M
- K4D
- K4E
- K4F
- K4L
- K4M
- K4N

- L2E
- L3E
- S2ES
- S3E
- S3F
- S3L
- S3L2
- S3Q2
- S4E

- S4E2
- S4E6
- S4F
- S4K
- S4L
- S4L2
- S4Q2
- S4S

- S6A
- S6A2
- S6A3
- S6B
- S6B3
- S6E
- S6K
- S6S



For ISUZU



3LD1



4FB1



4JJ1



4LE1



4LE2



D201

Hot Sale Engine Model For Isuzu

- | | | | | | | |
|--------|--------|--------|--------|--------|--------|---------|
| · 3AD1 | · 3LD1 | · 4FB1 | · 4JB1 | · 4LE2 | · 6KR2 | · 6WF1 |
| · 3FA1 | · 3LD2 | · 4FC1 | · 4JC1 | · 6BB1 | · 6QA1 | · 6WG1 |
| · 3KC1 | · 4BA1 | · 4FE1 | · 4JG1 | · 6BD1 | · 6RB1 | · C221 |
| · 3KC2 | · 4BC2 | · 4HE1 | · 4JG2 | · 6BG1 | · 6RK2 | · C240 |
| · 3KR1 | · 4BD1 | · 4HF1 | · 4JJ1 | · 6HE1 | · 6SA1 | · D201 |
| · 3KR2 | · 4BD2 | · 4HG1 | · 4LB1 | · 6HH1 | · 6SD1 | · 10PD1 |
| · 3LA1 | · 4BE1 | · 4HK1 | · 4LE1 | · 6HK1 | · 6WA1 | · 10PE1 |
| · 3LB1 | · 4BG1 | · 4JA1 | | | | |

All OEM part numbers and logos are to be used for identification purposes only.

FOR KUBOTA

Diesel Engine

- Z482 · D1703 · V2403
- D722 · D1803 · V2607
- D782 · V1505 · V3300
- D1105 · V1902 · V3307
- D1305 · V2003 · V3600
- D1503 · V2203 · V3800

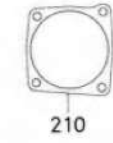
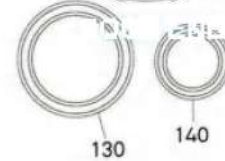
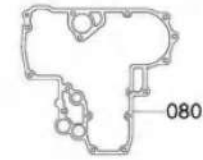
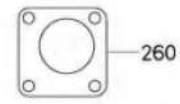
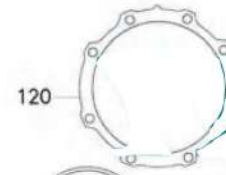
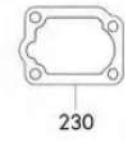
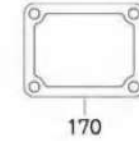
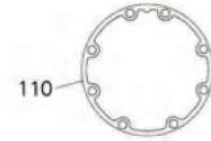
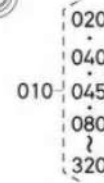
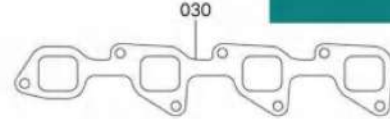
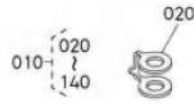

FOR MITSUBISHI

Diesel Engine

- 4M40 · K3F · S3E
- 6D14 · K3H · S3L
- 6D15 · K3M · S4E
- 6D16 · K4D · S4E2
- 6D22 · K4E · S4L
- 6D24 · K4F · S4Q2
- 6D31 · K4H · S4S
- 6D34 · K4M · S6E2
- K3B · K4N · S6S

FOR YANMAR

Diesel Engine

- 3TNE68 · 3TNE82 · 4TNV94
- 2TNV70 · 4D84-1 · 4TNE94
- 3TNV70 · 4D84-2 · 4TNV98
- 3TNE72 · 4D84-3 · 4TNE98
- 3TNV76 · 4TNV84 · 4TN100
- 3TN78 · 4TNE92 · 4TNV106
- 4TN78 · 4TNV88 · 4TNE106
- 3TNV82 · 4TNE88

FOR ISUZU

Diesel Engine

- 3KC1 · 4HK1 · 6BG1
- 3KR1 · 4JB1 · 6HK1
- 3KR2 · 4JJ1 · 6SD1
- 3LA1 · 4LE1 · 6WG1
- 3LB1 · 4LE2 · C240
- 3LD1 · 6BD1 · D201
- 3LD2

FOR LIEBHERR

Diesel Engine & Excavator

- R914 · R924 · R934B
- R944B · D924T · D926T

FOR PERKINS

Diesel Engine

- 1004-4 · 404D-15 · 1104D-44T
- 1004-4T · 404D-22T · 1104D-44TA
- 1004-40T · 404D-22TA · 1106D-E66TA
- 1004-40TA · 403D-17 · 1106C-E66TA
- 903-27T · 404C-22 · 1104C-44
- 1103C-33TA · 404C-22T · 1104C-44T
- 1103A-33T · 1104D-E44TA · 1104C-E44TA
- 402D-05

适用以下各大品牌发动机机型

FOR VOLVO

Diesel Engine

- D2.6A • D6D • D12D
- D4D • D7E
- D6E • D7D

FOR CAT

Diesel Engine

- C2.4 • C7 • 3066
- C2.6 • C7.1 • 3116
- C3.3 • C9 • 3126
- C6.4 • C-9 • 3306
- C6.6 • S6K • 3406

FOR CUMMINS

Diesel Engine

- A2300 • QSB6.7 • QSL9
- B3.3 • 6CT • M11
- QSB3.3 • LT10 • NTA855
- 4BT • NH220
- 6BT

FOR DOOSAN

Diesel Engine

- DB58 • DE08 • D2366
- D1146 • DL08 • DE12T

FOR KOMATSU

Diesel Engine

- 4D94 • 4D105 • 4D120
- 4D95 • 6D105 • 6D125
- 4D98 • 6D107 • 4D130
- 6D95 • 6D108 • 6D140
- 4D102 • 6D110 • 6D155
- 6D102 • 6D114 • 6D170

FOR HINO

Diesel Engine

- W04D • H07C • J05E
- W06D • H07D • J08C
- H06C • J05C • J08E

